

PVC Deluxe Marquee

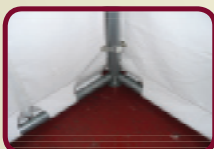

Nicoll Industries

**Seen enough? Ready to
order this product? Call
01283 510 570**

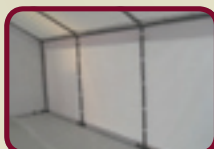

This premium PVC Marquee is for the more discerning customer, who demands the best quality and the highest specification. A hard wearing robust structure which is ideal for commercial use.

Product Features:

- Steel tube 50mmx2mm grey powder coated slot together steel framework
- Lettered poles for ease of erection
- 600gsm PVC UV stabilised covers
- Fire retardant to BS7837 with certificate and care guide
- Rectangular clear PVC windows along the eaves or plain sides option
- End panels with large zipper doorways with buckle tags
- Heavy duty velcro at legs with elasticated bungees to secure covers to frame
- Wraparound ends and corner leg covers instead of zips for durability and rip prevention
- Ground bars as standard with locator pins
- Skirt as standard to be pegged down and reduces wind or breeze entering marquee
- Velcro roof edges and sides to reduce water entry during inclement weather

Uses:

- Garden parties
- BBQs
- Family celebrations
- Weddings
- Maintenance shelter
- Storage
- Show stands
- Trader stalls
- Exhibitions
- Fundraising
- To purchase to hire out

Why buy?

- Individual 2m side sections
- Ground bar sleeves for tight walls
- Delivery to anywhere mainland UK
- Next day delivery available
- Comes in many different sizes
- Thicker, stronger, more durable poles
- Highest quality materials available
- Side skirt for tidier finish
- Wrap around corners instead of corner zips which can split under pressure

Available Sizes:

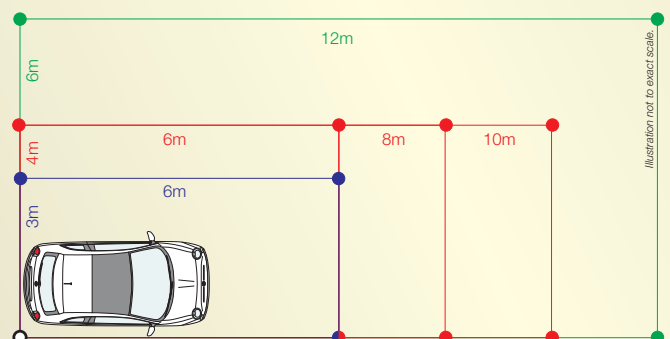

call us today on:

01283 510 570

for more info please visit our website: www.nicoll-industries.co.uk



Nicoll Industries

Accessories

Ready to order? Just call
01283 510 570

Our Marquee accessory range is extensive. So in order to help you choose your accessories, we used our expertise to categorise the items in order of recommendation. Please call our sales team for more information on any of the accessories and we will be happy to assist you!

Highly Recommended



Tie Down Kits



Sand Bags

More Accessories



Bungees



Softex Flooring

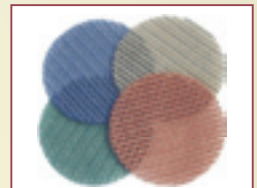

Softex Flooring

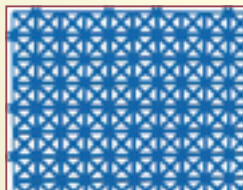

Flexible matting

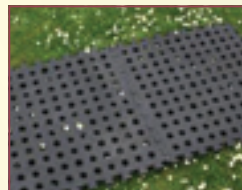

Easylock Floor



Ground Bar Ramp

Also Recommended



Wall Linings

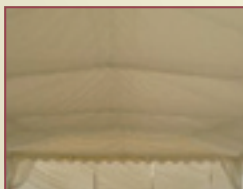

Ceiling Linings



Globe Lights



Spare Parts



Spare Parts



Interlock Floor



Weavatex Floor

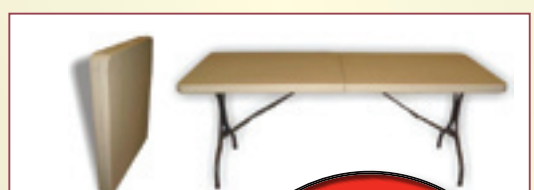

Folding Tables



call us today on: **01283 510 570**
for more info please visit our website: www.nicoll-industries.co.uk



Nicoll Industries